

Product Description

The Protector™ is a collision sensor, or crash protection device, designed to prevent costly damage to robotic end-effectors resulting from robot crashes. The Protector's features include: Automatic reset, high repeatability, large moment and torsional rotation, rugged design and low cost. The Protector's capabilities and features make it an excellent investment to protect robots and tooling while minimizing downtime and eliminating the need for human intervention. The unit has been tested to operate over millions of cycles without failure.



Angular Crash



Compressive Axial Crash



Torsional Crash

Product Advantages

High Repeatability: Following a collision, the use of precision components enables the Protector to reset to within 0.001 inches of its original position.

Generous Range of Motion: During a crash the Protector can comply large distances in response to any type of crash (angular, axial or torsional), thus allowing the robot controller ample time to take corrective action.

Energy Absorption: The impact energy generated during a collision is absorbed by a pneumatic chamber. This protects the tooling from being damaged by crashes. After absorption, this energy is redirected to automatically reset the device upon removal from the crash-causing object.

Consistent Break-away Response: Break-away response is similar at a given pressure independent of whether the crash is angular, compressive axial, or torsional.

Convenient Mounting Surfaces: Threaded and through-hole mountings are provided for added flexibility. The simple mounting patterns reduce the stack height of the Protector and tooling assembly.

Cost-effective: The Protector is a strong, reliable, low-cost unit engineered to enable you to affordably enhance manufacturing productivity.

Automatic Reset: After a crash, the Protector will self-reset when the robot removes the tooling from the crash situation. This eliminates the need to enter the robot cell to reset the crash protection device.

Optional Spring Provides Two Trip Points: Air pressure may be used to obtain a higher break-away point during high-inertia motion and the optional preset spring only for a lower break-away point. Inquire about the range of preset springs available for each model.

Quick-Response Crash Detection: The 2-wire circuit can be configured as sinking or sourcing, AC or DC. Nuisance tripping of the signal is avoided with the switch set to actuate within 0.020 inches of axial motion. A Brad Harrison connector and cable are used to pass the crash signal.

Robust Design: The Protector is designed with generous use of hardened tool steel in contact and wear areas, to ensure the unit's long-life and strength.

Environmental Protection: Optional protection boots are available to prevent water or oil-based machine coolants or sparks and weld spatter from entering the unit.

Optional Interface Plates: Blank or custom-designed adapter plates to attach both the robot and the tooling are available.



How to Select a Protector Model

For a successful application, the Protector must be sized appropriately. Contact ATI at 919-772-0115 for assistance with model selection or use the following information. To select the correct model, you must consider all forces acting on the Collision Sensor: Static, Dynamic, and Working forces, produced by the end-of-arm tooling while performing its intended task. Once a specific model is selected, the nominal pressure setting for the break-away point must be determined. The required air pressure setting must be readily available with ample range. For example, a calculated pressure setting of 50 psi should have an adjustable range of 25-75 psi.

The selection process is as follows:

1. Calculate Applied Loads:

Use Figure 1 on page 4 to convert the forces acting on the end-effector tooling into the resulting moment, torque, and axial loads applied to the Protector. Use the diagram shown in Figure 1 and the formulas below to calculate the worst case applied loads for your application. All three load cases—Axial, Torque, and Moment—should be assessed for their Static, Dynamic, and Working force components.

Note: Not all of the component forces (Static, Dynamic, and Working) are present during all phases of the robot program. As a result, the worst case conditions for Axial, Torque, and Moment loads may occur at different times in the program.

Formulas:

$$\text{Axial Load (F)} = F_2$$

$$\text{Torque (T)} = F_3 \cdot D_3$$

$$\text{Moment (M)} = \sqrt{(F_1 \cdot D_1)^2 + (F_2 \cdot D_2)^2}$$

(F1, F2, and F3 consist of the sum of their respective Static, Dynamic, and Working force components; and should always be positive for purposes of calculating break-away pressure settings.)

a. Static Force: The load applied by tooling weight while the robot arm is idle. This includes the weight of all parts attached to the Protector, acting at the assembly's center of gravity along the direction of gravity.

b. Dynamic Force: The inertial force imposed at the center of gravity of the tooling due to acceleration of the robot arm. They are additive to static forces and must be carefully considered to ensure proper sizing of the Protector.

c. Working Force: Forces generated on the tooling under normal working conditions. Once these forces and their locations are known, they must be converted into loads on the Protector using the above formulas.

2. Select a Protector Model:

Once the approximate loads are known from step one, select a model that has a nominal moment and torque rating above the combined loads.

3. Obtain Required Pressure Setting:

The pressure setting required can be approximated from the following formula:

$$P = P_M + P_T + P_F$$

Where P_M , P_T , and P_F are the pressure components related to the Moment(M), Torque(T), and Force(F) load components expected at the break-away.

P_M , P_T , and P_F are calculated using the formulas in Tables 1 or 2, where M, T, and F are the expected loads at the set pressure break-away.

Table 1: Protector Pressure Setting Calculations
(English Units: lb-in, psi, lb)

Protector Model	(Moment) $P_M =$	(Torque) $P_T =$	(Axial) $P_F =$
SR-61	$(M \times 0.376) - 3.3$	$(T \times 0.444) - 6.3$	$F \times 0.462$
SR-81	$(M \times 0.172) - 0.2$	$(T \times 0.168) - 0.8$	$F \times 0.233$
SR-101	$(M \times 0.085)$	$(T \times 0.081) - 2.8$	$F \times 0.147$
SR-131	$(M \times 0.030)$	$(T \times 0.033) - 1.7$	$F \times 0.085$
SR-176	$(M \times 0.013)$	$(T \times 0.012) - 2.4$	$F \times 0.045$
SR-221	$(M \times 0.0052)$	$(T \times 0.0065) + 7.3$	$F \times 0.029$

Table 2: Protector Pressure Setting Calculations
(Metric Units: N-m, Bar, N)

Protector Model	(Moment) $P_M =$	(Torque) $P_T =$	(Axial) $P_F =$
SR-61	$(M \times 0.2294) - 0.2$	$(T \times 0.2708) - 0.4$	$F \times 0.00719$
SR-81	$(M \times 0.1052)$	$(T \times 0.1027) - 0.1$	$F \times 0.00361$
SR-101	$(M \times 0.0517)$	$(T \times 0.0495) - 0.2$	$F \times 0.00228$
SR-131	$(M \times 0.0183)$	$(T \times 0.0199) - 0.1$	$F \times 0.00132$
SR-176	$(M \times 0.0077)$	$(T \times 0.0075) - 0.2$	$F \times 0.00070$
SR-221	$(M \times 0.0032)$	$(T \times 0.0040) + 0.5$	$F \times 0.00045$

Example: For an SR-81 with a moment of 100 lb-in, torque of 50 lb-in, an axial load of 20 lbs, and an acceleration of 2 G's, the pressure setting is calculated as follows:

$$\begin{aligned} P &= ((100 \times 0.172) - 0.2) + ((50 \times 0.168) - 0.8) + (20 \times 0.233) \\ &\quad + ((100 \times 2 \times 0.172) - 0.2) \\ &= 17 + 7.6 + 4.66 + 34.2 \\ &= 63.46 \end{aligned}$$

A nominal air pressure setting of 63 psi is required.

MODEL SPECIFICATIONS

Figure 1: Protector Loading Diagram

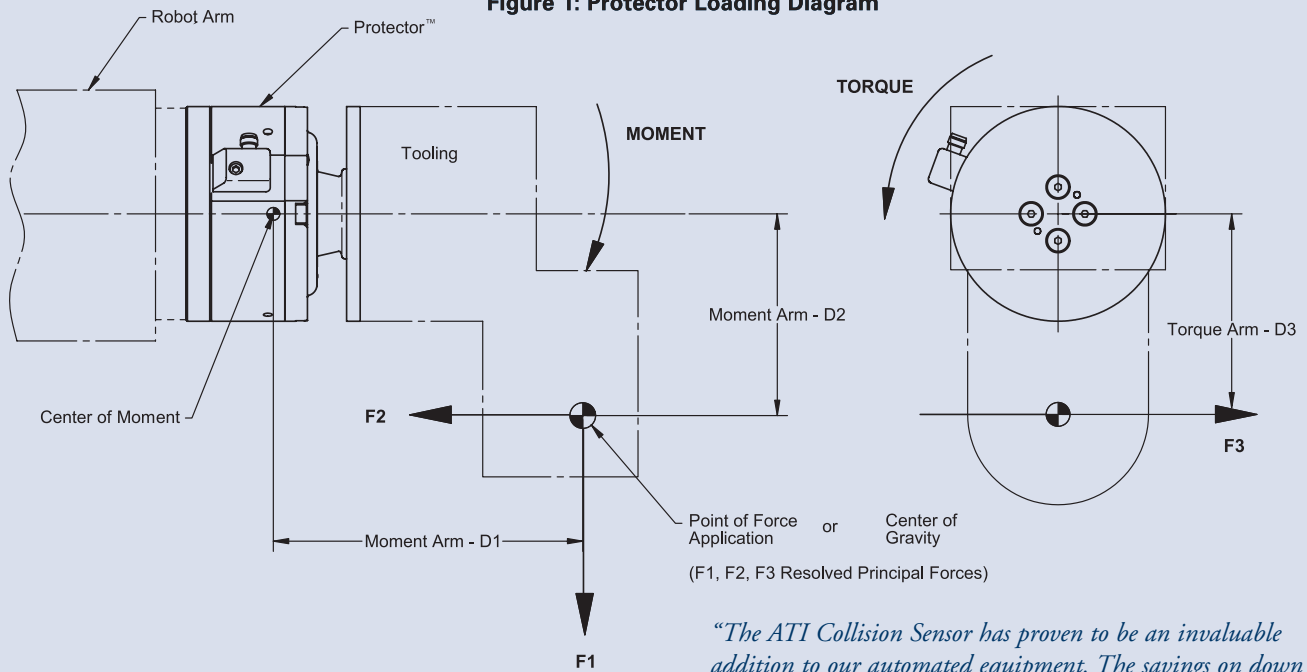

“The ATI Collision Sensor has proven to be an invaluable addition to our automated equipment. The savings on down time and repairs is immeasurable.”

Daniel K. DiAndrea
Project Engineer
National Manufacturing Co., Inc.

Specification Description	SR-61	SR-81	SR-101	SR-131	SR-176	SR-221
Angular Displacement	±11°	±13°	±12°	±10°	±10°	±8°
Torsional Displacement	±20°	±25°	±25°	±20°	±20°	±20°
Axial Displacement	0.22 in (5.59 mm)	0.34 in (8.66 mm)	0.40 in (10.2 mm)	0.46 in (11.7 mm)	0.63 in (16 mm)	0.63 in (16 mm)
Maximum Air Pressure Setting	90 psi (6.2 bar)	90 psi (6.2 bar)	90 psi (6.2 bar)	90 psi (6.2 bar)	90 psi (6.2 bar)	90 psi (6.2 bar)
Weight	.70 lb (0.32 kg)	1.28 lb (0.58 kg)	2.6 lb (1.2 kg)	5.1 lb (2.3 kg)	12.0 lb (5.4 kg)	25.1 lb (11.4 kg)
Moment Break-away @ 90 psi (6.2 bar)	248 lb-in (28.0 N-m)	521 lb-in (59.0 N-m)	1060 lb-in (120 N-m)	3000 lb-in (339 N-m)	7130 lb-in (806 N-m)	17390 lb-in (1965 N-m)
Torque Break-away @ 90 psi (6.2 bar)	216 lb-in (24.4 N-m)	540 lb-in (61.0 N-m)	1145 lb-in (130 N-m)	2780 lb-in (314 N-m)	7530 lb-in (851 N-m)	13250 lb-in (1497 N-m)
Axial Break-away @ 90 psi (6.2 bar)	198 lb (880 N)	385 lb (1713 N)	610 lb (2713 N)	1060 lb (4715 N)	2000 lb (8900 N)	3100 lb (13800 N)
Diameter	2.36 in (60 mm)	3.15 in (80 mm)	3.94 in (100.1 mm)	5.12 in (130 mm)	6.89 in (175mm)	8.66 in (220 mm)
Height*	1.78 in (45.1 mm)	2.18 in (55.4 mm)	2.48 in (63 mm)	2.95 in (75 mm)	3.94 in (100.1 mm)	4.65 in (118.1 mm)

*Height does not include optional tool or robot side interface plates.

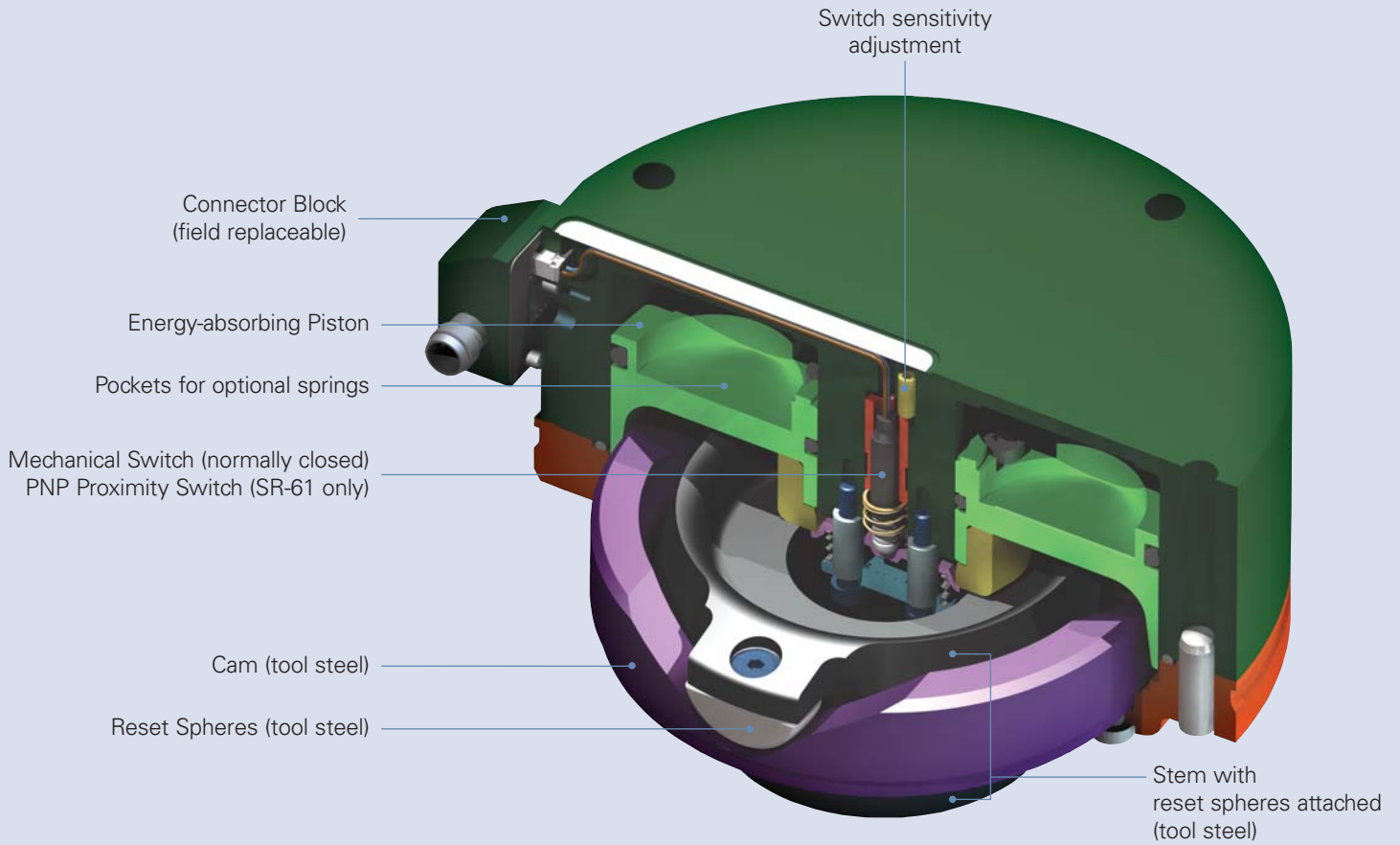

“With the automatic reset feature, there is never a reason to enter the robot cell and realign tooling. Now, when an interference occurs, it is as simple as correcting the cause and restarting the equipment.”

Jeff Reust
Automation Engineer
BOSCH Automotive

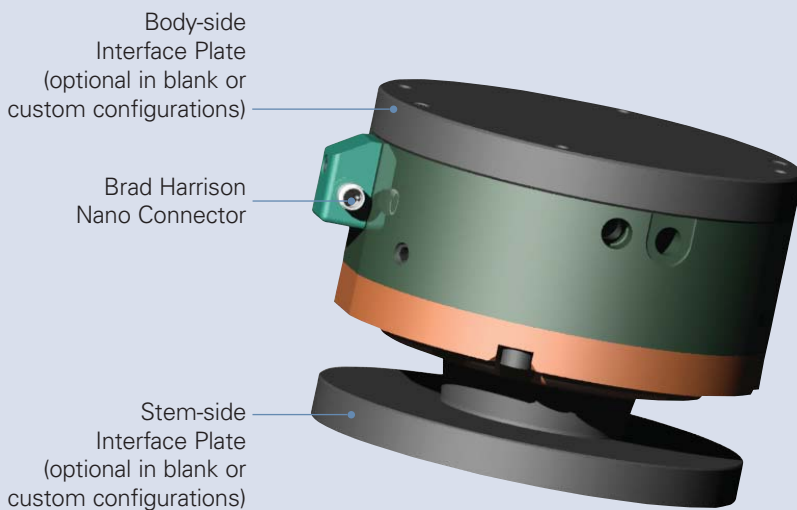

PERFORMANCE DATA

SR-61 Performance

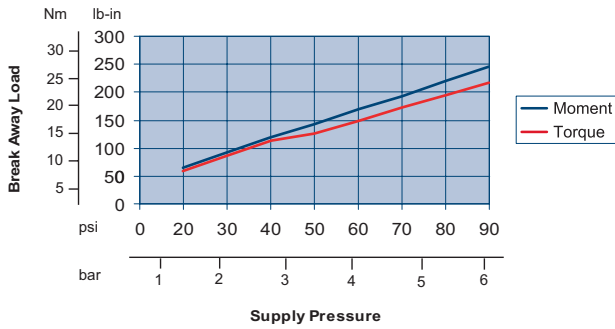

Axial Break-away Load (lb) = Pressure (psi) x 2.2
(N) = Pressure (bar) x 86.4

SR-131 Performance

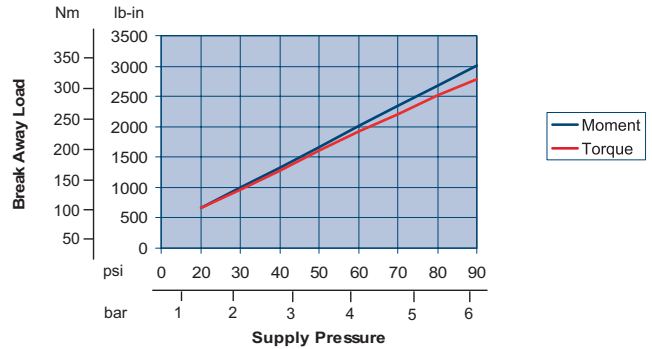

Axial Break-away Load (lb) = Pressure (psi) x 11.8
(N) = Pressure (bar) x 463.4

SR-81 Performance

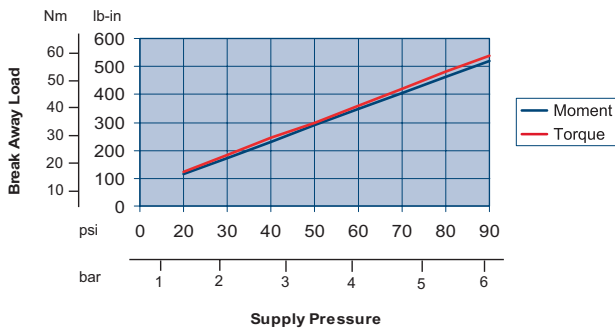

Axial Break-away Load (lb) = Pressure (psi) x 4.3
(N) = Pressure (bar) x 168.9

SR-176 Performance

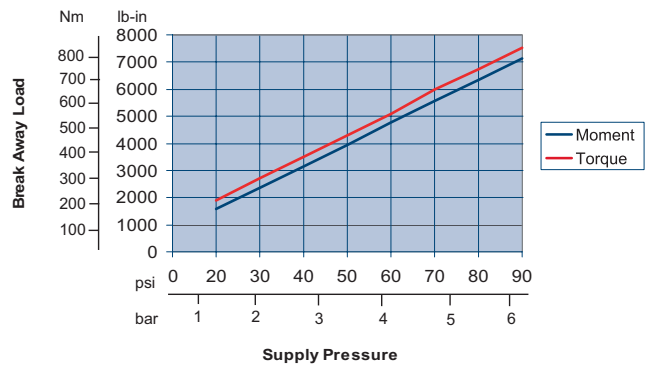

Axial Break-away Load (lb) = Pressure (psi) x 22.2
(N) = Pressure (bar) x 871.9

SR-101 Performance

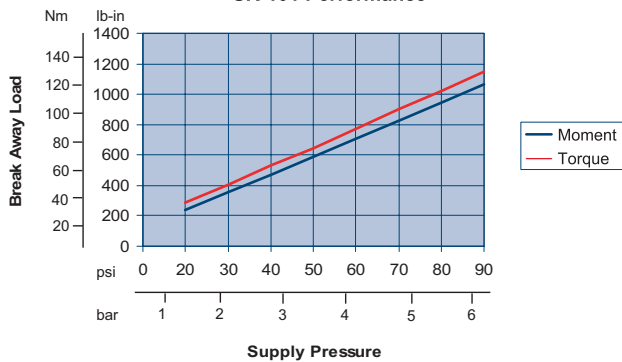

Axial Break-away Load (lb) = Pressure (psi) x 6.8
(N) = Pressure (bar) x 267

SR-221 Performance

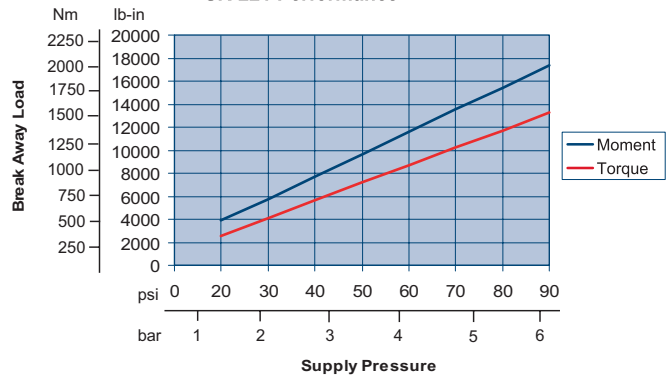

Axial Break-away Load (lb) = Pressure (psi) x 34.5
(N) = Pressure (bar) x 1354.9

Note: Moment graphs based on point of switch opening at approximately 1° deflection.

HOW TO ORDER

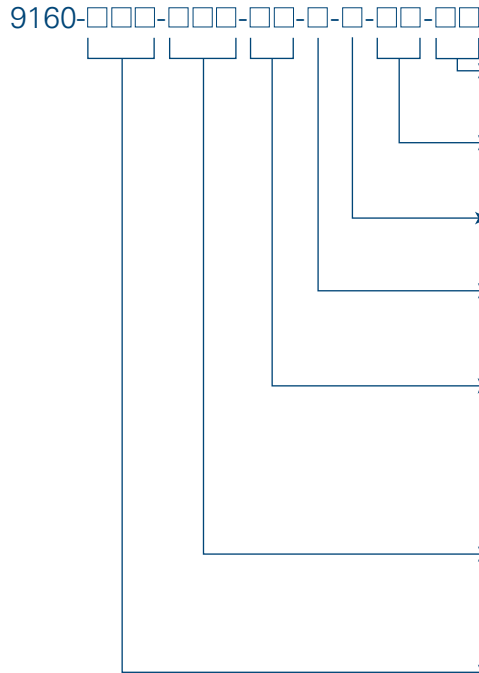

SR-61, SR-81, SR-101, SR-131, SR-176 & SR-221	
Blank: PNP Proximity Switch (Standard, SR-61 only) S1: NPN Proximity Switch (SR-61 only)	
C2: Weld Spatter Shield (not available for SR-221) C5: Coolant Protection Viton Boot (IP65 rated)	
B: Blank Interface Plate (Body) N: No Interface Plate	S: Blank Interface Plate (Stem) T: Two blank Interface Plates (Body & Stem)
SR-61, SR-81 & SR-101 R: #10-32 (M5) Air Supply Port [No other option]	SR-131, SR-176 & SR-221 R: 1/8 NPT Air Supply Port G: G 1/8 Air Supply Port
BN: No cable BB: High-flex cable with screw-on connector, 5M (16 ft.) long with flying leads BC: High-flex cable with 90° snap-on connector, 5M (16 ft.) long with flying leads BD: High-flex cable with 90° screw-on connector, 10M (32 ft.) long with flying leads BU: High-flex cable with snap-on connector, 5M (16 ft.) long with flying leads BT: High-flex cable with snap-on connector, 10M (32 ft.) long with flying leads	
P00: No Spring Assist P05: Spring assist of 5 psi pressure P10: Spring assist of 10 psi pressure P15: Spring assist of 15 psi pressure (not available for SR-131)	
061: SR-61 model 081: SR-81 model 101: SR-101 model 131: SR-131 model 176: SR-176 model 221: SR-221 model	

SR-81 Collision Sensor with C5 Coolant Protection Boot IP65 rated



SR-81 Collision Sensor with C2 Weld Spatter Shield



Other ATI Products

Robotic/Automatic Tool Changer

A high-precision, rugged device that automatically changes tooling. Patented fail-safe locking mechanism that uses No-Touch Locking™ technology, allowing plate separation when locking.

Robotic/Automatic Tool Changers for Heavy Automation

This series of modular tool changers are designed specifically for high-payload and high-moment applications. **Utility Modules** to pass air, fluid, and electrical signals are also available for use in non-tool changer applications. Useful for processes requiring repeated connection/disconnection of utilities.

Robotic and CNC Deburring Tools

These air-driven robotic tools cover a wide variety of automated deburring applications with fast cycle times and clean, accurate cuts. The Radial Compliant Deburring Tool is designed for removal of parting lines and flash, while the Axial Compliant Deburring Tool is specially designed for edge deburring and chamfering.

Multi-Axis Force/Torque Sensor

Measures the full six components of force and torque. High overload protection and high signal-to-noise ratio. Used in robotic and research applications.

Robotic Rotary Joint

A device that allows unlimited rotation of end-of-arm tooling without tangling or twisting robot lines. Utilizes advanced slip-ring technology to pass electrical and pneumatic signals from robot to tooling.

Automated Assembly Alignment Device

An insertion device using Remote Center Compliance technology that helps assembly machines automatically align close-fitting parts, preventing jamming and galling.

Company Profile

ATI Industrial Automation is a world-leading developer of Automatic Tool Changers, Multi-Axis Force/Torque Sensing Systems, Compliance Devices, Robotic Collision Sensors, Robotic Deburring Tools, and Robotic Rotary Joints. Our products are found in thousands of successful applications around the world.

Since 1982, our engineers have been developing cost-effective, state-of-the-art products and solutions to improve manufacturing productivity.

Our Mission is to provide customers around the world with high-quality robotic peripheral devices, tooling and sensors that enhance customer profitability by increasing the effectiveness, flexibility, safety and productivity of their automation applications. We accomplish this through continuous improvement of existing products, product customization and new product innovation.

Our engineering-centric staff focuses on providing customer solutions to robotic, automation and sensing applications.

Our Quality Policy

ATI Industrial Automation strives to provide customer satisfaction through continual improvement of on-time delivery, quality and reliability, and a constant focus on innovation and profitability.



Engineered Products for Robotic Productivity

Pinnacle Park
1031 Goodworth Drive
Apex, NC 27539 USA

+1 919.772.0115
+1 919.772.8259 fax
E-mail: info@ati-ia.com
www.ati-ia.com